

VERTICAL

Aluminum access ladder. (1)

Ladder access the upper floors, or access to any large extent, is produced according to D/Lgs. 50/2005 and EN 131. Built in extruded aluminum crimped steps amounts to creating a structure.

TECHNICAL

- Profile: 65x25 mm;
- Steps plans striated non-slip: 3 cm;
- Distance between steps: 28 cm;
- Number steps: 6-14;
- Ground height last step: 17 cm;
- Outer width: 43 cm;
- Number fixing clamps: 6 (Without wall mounting bolts);
- Proof certificate according to european standards.



EQUIPMENT

- Non-slip plates;
- Labels and use and maintenance manual.

OPTIONAL

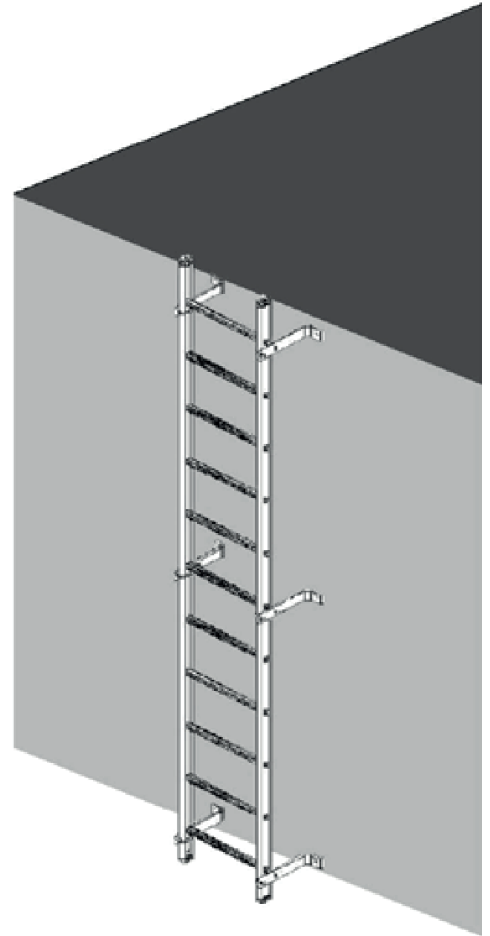
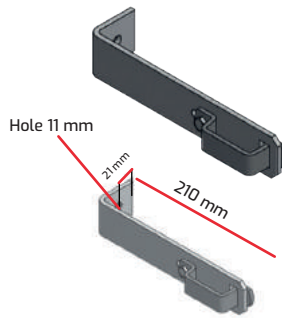
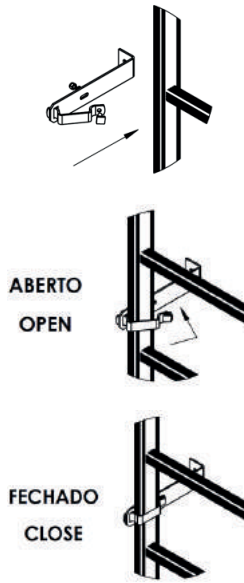
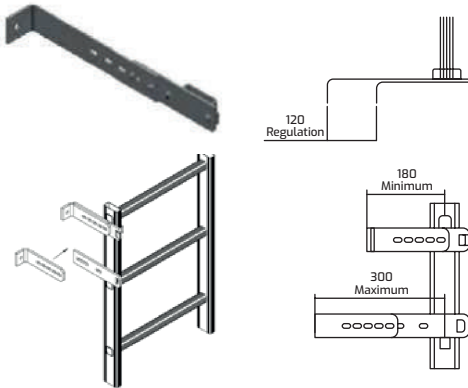
- Adjustable fixer - 18-30 cm.



| REF |  |  |  | KG | € |
|-------|---|---|---|-------|---|
| | | m | mm | | |
| 10099 | 6 | 1.80 | 65X25 | 4.00 | |
| 10100 | 7 | 2.08 | 65X25 | 5.00 | |
| 10101 | 8 | 2.36 | 65X25 | 6.00 | |
| 10102 | 9 | 2.64 | 65X25 | 7.00 | |
| 10103 | 10 | 2.92 | 65X25 | 8.00 | |
| 10104 | 11 | 3.20 | 65X25 | 9.00 | |
| 10105 | 12 | 3.48 | 65X25 | 10.00 | |
| 10106 | 13 | 3.76 | 65X25 | 11.00 | |
| 10107 | 14 | 4.04 | 65X25 | 12.00 | |

(1) the use of access equipment, is not a substitute for proper training, training and use of safety equipment to carry out the work.

